

TOOLS & EQUIPMENT

CATALOGUE

INDUSTRI

TOOLS & EQUIPMENT



'Let's Get To Work!'

1 Ton Chain Hoists	
System Code	Description
B0000861	1T Chain Hoist x 3 m Lift with a Load Limiter
B0000862	1T Chain Hoist x 4 m Lift with a Load Limiter
B0000863	1T Chain Hoist x 5 m Lift with a Load Limiter
B0000864	1T Chain Hoist x 6 m Lift with a Load Limiter

2 Ton Chain Hoists	
System Code	Description
B0000870	2T Chain Hoist x 3m Lift with a Load Limiter
B0000871	2T Chain Hoist x 4m Lift with a Load Limiter
B0000872	2T Chain Hoist x 5m Lift with a Load Limiter
B0000873	2T Chain Hoist x 6m Lift with a Load Limiter

3 Ton Chain Hoists	
System Code	Description
B0000875	3T Chain Hoist x 3m Lift with a Load Limiter
B0000876	3T Chain Hoist x 4m Lift with a Load Limiter
B0000877	3T Chain Hoist x 5m Lift with a Load Limiter
B0000878	3T Chain Hoist x 6m Lift with a Load Limiter

5 Ton Chain Hoists	
System Code	Description
B0000880	5T Chain Hoist x 3m Lift with a Load Limiter
B0000881	5T Chain Hoist x 4m Lift with a Load Limiter
B0000882	5T Chain Hoist x 5m Lift with a Load Limiter
B0000883	5T Chain Hoist x 6m Lift with a Load Limiter

Product Code	LR9115	LR9125	LR9130	LR9135
Rated Capacity (T)	1	2	3	5
Standard Lift (m)	3	3	3	3
Falls of Chain	1	1	2	2
Effort to Lift Rated Capacity (N)	309	320	360	414
Test Load (kN)	12.5	25	37.5	75
Net Weight (kg)	11.9	18.5	24	42.4
Load Chain Diameter (mm)	6	8	7.1	10
Weight per Extra Meter Lift (kg)	1.8	2.3	4.2	4.9
Clearance Dimensions				
A (mm)	143	152	152	181
B (mm)	156	198	182	266
C (mm)	317	414	465	636
D (mm)	27	36	38	48



B0000870



B0000871





Chain Hoists

Every Lift-All Hoist is Supplied with an Overload Protection Device in the Form of a Slip-Clutch.

1. LIFT-ALL chain hoists are fully compliant with the latest SANS 1594:2007 standards
2. The hoists have forged, durable, heat-treated, compact and convenient hooks that swivel 360 degrees.
3. The top and bottom hooks are drop-forged and fracture-resistant. When overloaded, they will open gradually as a safety indicator, rather than reaching ultimate breaking strength and dropping the load, possibly causing injury or death.
4. All of the required markings are forged into the hooks during the manufacturing process.
5. Thrust bearings are used instead of a dry yoke to ensure rotation under full load.
6. The hoists have thick, pressed steel gear and hand wheel covers that are resistant to external shock and able to work under extreme conditions.
7. The hoists have an Internal cover to protect the gears and a cover to protect the braking system.
8. There is a fully enclosed, self-activating Weston type load brake with large asbestos-free friction discs for a trouble-free life.
9. To ensure optimum safety, the hoists are backed by a double pawl ratchet system.
10. LIFT-ALL hoists have forged safety latches that are fitted to the top and bottom hooks to withstand side loading.
11. The hoists are equipped with a load chain guide mechanism and chain stripper to facilitate smooth movement and trouble-free operation.
12. The hoists have an ultra-strong gauged Grade 10 load chain to resist wear.
13. Chain stoppers are used to prevent failure due to excessive lowering.



Lever Hoists	
System Code	Description
B0000852	0.75T Lever Hoist x 3 m Lift with Load Limiter

Lever Hoists	
System Code	Description
B0000853	1.5T Lever Hoist x 3 m Lift with Load Limiter
B0000854	1.5T Lever Hoist x 4 m Lift with Load Limiter
B0000855	1.5T Lever Hoist x 5 m Lift with Load Limiter
B0000856	1.5T Lever Hoist x 6 m Lift with Load Limiter



B0000852

Lever Hoists	
System Code	Description
B0000857	3.0T Lever Hoist x 3m Lift with Load Limiter
B0000858	3.0T Lever Hoist x 4m Lift with Load Limiter
B0000859	3.0T Lever Hoist x 5m Lift with Load Limiter
B0000860	3.0T Lever Hoist x 6m Lift with Load Limiter

Product Code	505075VM	505150VM	505300VM
Rated Capacity (T)	0.75	1.5	3
Test Load (T)	1.125	2.25	4.5
Standard Lift (m)	1.5	1.5	1.5
Minimum Distance between Two Hooks (mm)	295	335	450
Efforts Required at Capacity (N)	140	234	363
Number of Load Chains	1	1	1
Diameter of Load Chain (mm)	6	7.1	9
A (mm)	152	175	195
B (mm)	128	148	181
C (mm)	295	335	450
D (mm)	256	368	368
E (mm)	26	38	37
Net Weight (kg)	7.7	10.6	20.0

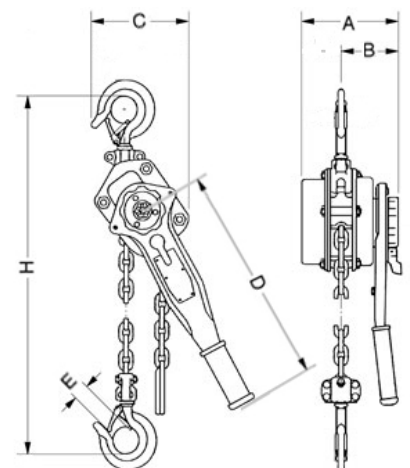



Lever Hoists

Every Lift-All Hoist is Supplied with an Overload Protection Device in the Form of a Slip-Clutch.

1. LIFT-ALL chain hoists are fully compliant with the latest SANS 1594:2007 standards
2. The hoists have forged, durable, heat-treated, compact and convenient hooks that swivel 360 degrees.
3. The top and bottom hooks are drop-forged and fracture-resistant. When overloaded, they will open gradually as a safety indicator, rather than reaching ultimate breaking strength and dropping the load, possibly causing injury or death.
4. All of the required markings are forged into the hooks during the manufacturing process.
5. Thrust bearings are used instead of a dry yoke to ensure rotation under full load.
6. The hoists have thick, pressed steel gear and hand wheel covers that are resistant to external shock and able to work under extreme conditions.
7. The compact lever design improves weight distribution and handling.
8. A safety locking system to prevent the load dropping during the free-chaining mode.
9. Optimum gear ratio for easy operation.
10. There is a fully enclosed, self-activating Weston type load brake with large asbestos-free friction discs for a trouble-free life.
11. To ensure optimum safety, the hoists are backed by a double pawl ratchet system.
12. LIFT-ALL hoists have forged safety latches that are fitted to the top and bottom hooks to withstand side loading.
13. The hoists are equipped with a load chain guide mechanism and chain stripper to facilitate smooth movement and trouble-free operation.
14. The hoists have an ultra-strong gauged Grade 10 load chain to resist wear.
15. Chain stoppers are used to prevent failure due to excessive lowering.

Experience KITO's Quality, Productivity & Durability

Electric Chain Hoists

KITO's electric chain hoists are designed to provide peak performance during tough jobs and in demanding conditions. These electric chain hoists offer quiet operation and minimal vibration, which lowers workplace noise pollution, helping reduce worker fatigue and extends the life of the hoist. The practical durability of the hoists allow you to get the job done safely and worry-free.



Hand Chain Blocks

KITO's hand chain blocks are unmatched in pulling power in extreme conditions. To prove this, Kito's chain blocks and chains are the only products in this field branded with the SABS logo. Exceptional, heavy-grade components make these long-lasting workhorses endure severe weather conditions. It has been proven to reduce the total cost of ownership through its durability and safety design.



Lever Hoists

KITO's lever hoists are smaller, lighter and stronger than any other lever hoist currently on the market. Their proven strength and durability enable them to perform in an endless array of harsh applications.



Trolleys & Accessories

Trolleys play an integral role in moving loads around. Various types of trolleys include push, geared and electric trolleys. In many cases, it is important to have a fixed anchor point on a beam by means of a clamp.





Experience KITO's Quality, Productivity & Durability

Jib Crane

KITO's Jib crane range offers a complete lifting system for the workplace. It also offers a particularly flexible material flow solution, tailored to your needs and work processes.



Special Applications

The requirement to design flexible and economical processes in-house, are dependent on the type of industry. Each solution is optimally tailored to the customers' needs.



Spares

The average life cycle of a KITO hoist is often more than a decade. KITO hoists are refurbished using genuine spare parts that guarantee a long working life.



Load Chains

The symbiosis between a hoist and a chain is of paramount importance to guarantee the best possible safety, longevity and efficiency. Nickel-plated load chains are unique in the lifting world.



Marine and Offshore

Increasingly sophisticated vessels, more pressures on production efficiency and assembly speed, as well as the highest levels of onboard safety and reliability. These are the key issues for marine and offshore clients today, and the reasons why they turn to Kito to give them the marine lifting solutions they need to succeed.

Kito offers the products, systems and services for ships or offshore rigs of every size, as well as robust and efficient power management systems. The KITO offshore lifting equipment range is designed to be used in maritime areas, on oil rigs, cargo vessels or wind farms. The range includes all types of lifting equipment together with their components including electric chain or wire rope hoists, chain blocks and lever hoists. To maintain clean and reliable power for critical applications operating in highly unforgiving environments.

The ER2 electric hoist is designed for peak performance, even on the toughest jobs in the toughest conditions. Practical durability at its best, the ER2 lets you get the job done safely and worry-free.

The ER2 uses Kito's world-class, super-strength chain. Its shorter and narrower link profile allows for greater surface area contact, giving it a better wear resistance and overall tensile strength.



Capacity

- Single Speed: 1/8 to 20 metric tonnes.
- Dual Speed: 1/8 to 20 metric tonnes.

Standards

- CSA Approved.
- ASME B30.16.
- ASME H4.
- P55 Dust-Tight & Watertight.

Options

- Plastic, canvas or steel chain containers.
- L/S lift chain container.
- Lift lengths can be customized to suit the customers requirements.
- Plain, geared or motorized trolley mount.

Body

- Die-Cast Aluminum Frame.
- Completely sealed body for environmental protection.
- Low Headroom.

Gears

- Precision, induction-heated, durable Alloy Steel helical gears submersed in an oil bath.

Load Chain

- Ultra-strong, high-performance nickel-plated load chain, with a unique short link pitch for greater resistance to fatigue and wear and corrosion resistant.
- Grade 80.

Controls

- The controls are located on a central electrical panel.
- Control Voltage: 110 Volts.
- Easy to operate plug-in connectors.
- Adjustable, dual-speed, under-the-cover VFD (220 and 440 Volt dual speed models).
- (Optional) Ergonomic Cylinder Control ideal for repetitive tasks. Available in adjustable 2-speed (220/440 Volt) or Dual Speed (575 Volt).

Chain Guide

- L/S-lasting, heavy-duty Cast Iron construction, easily replaced without disassembling the hoist.

Ergonomic Pushbutton Station

- Impact-resistant plastic with moulded strain relief to prevent damage from pulling on the push button cord.
- P65 dust-tight and watertight.

Hooks

- The forged carbon steel hooks open gradually without fracturing under excessive loads. The bottom hook swivels 360 degrees.
- The self-closing top and bottom hooks have a heavy-duty hook latch.

Motor

- Three phase.
- Standard Voltage: 220/440/575 Volts.
- 60 Hertz.
- Class B.
- One extreme-duty, totally enclosed, fan-cooled (TEFC) squirrel cage.
- A motor fin, fan blade and fan cover design for optimum air flow.

Overload Protection

- A friction clutch is located in the gearbox between the motor and the load gear, prevents damage to the hoist in the event of excessive overloading.

Operating Conditions

- Recommended for use in conditions between -20°C to +40°C and humidity of 85% or lower.

Bearings

- High-quality, anti-friction ball and roller bearing designs.

Food & Beverage

Food Grade Electric Chain Hoist



1/2-2 Ton Capacities.

For use in Contaminant Controlled or Corrosive Environments.

Kito's Food Grade ER2 electric chain hoist is well suited for lifting applications in food, beverage and pharmaceutical processing industries where pristine cleanliness is critical. Food grade lubricants used on the load chain and in the gearbox are NSF H1 compliant for safe use in any facility where incidental contact with product is a concern. Customer specified options include white epoxy paint, Stainless Steel and nickel-plated hardware and nickel-plated load chain making this hoist well-suited for contaminant controlled or corrosive processing environments.

A Food Grade electronic chain hoist is shown with optional Stainless Steel bottom hook and chain container

380
VOLTS

Standard Food Grade Features



White Epoxy Paint

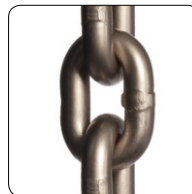

Nickel-Plated Load Chain



Food Grade Oil and Grease



Stainless Steel and Nickel-Plated Hardware



Fail-Safe Brake



White Epoxy Bottom Hook

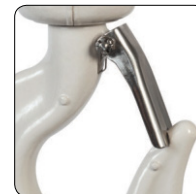

Stainless Steel Hook Latch



Extreme-Duty TEFC Motor

Duty Ratings	Single Speed	Adjustable 2 Speed & Dual Speed
FEM Class	3 m/2 m	3 m/2 m
Max. Starts/hr	360	240/120
% ED	60	40/20
Short Time Rating	60 Min.	30/10 Min.

- NSF H1 Compliant Food Grade Grease and Oil
- CE Certification
- Grade 80, Case-Hardened Chain
- IP55 Environmental Protection
- Nickel-plated load chain
- A Certificate of Conformance is included

Optional Application Kits

Corrosive Resistant Kits



Stainless Steel Bottom Hook



Stainless Steel Rubber Cushion & Nickel-Plated Stopper on No-Load Side



Stainless Steel Rubber Cushion & Nickel-Plated Stopper on 0.5T & 1T



Stainless Steel Chain Spring & Limit Plate on 2T



Corrosive Resistant Trolley Kits



Stainless Steel Trolley Wheels



Stainless Steel Trolley Wheels (MR2)



Nickel-Plated Suspension Shaft & Suspender

Accessories



Stainless Steel Chain Container



Plastic Chain Container



Fabric Chain Container



Protective Silicone Pendant Cover



Shown with an Optional Plain Trolley Mount Plastic Chain Container

Mounting Options

- Hook, plain, trolley or geared trolley for improved efficiency.
- Single speed/dual speed motorized trolley for improved load control.
- Perpendicular to beam (standard), or parallel to beam for operation in tight spaces. Perpendicular to beam ()

Headroom (Inches)								
Capacity (Tonnes)	Hook Mount		Plain Trolley Mount		Geared Trolley Mount		Motorized Trolley Mount	
	Standard Bottom Hook	Stainless Steel Bottom Hook	Standard Bottom Hook	Stainless Steel Bottom Hook	Standard Bottom Hook	Stainless Steel Bottom Hook	Standard Bottom Hook	Stainless Steel Bottom Hook
1/2	14.6	17.8	16.3	19.5	17.1	20.3	15.6	18.7
1	16.9	21.2	18.5	22.8	18.5	22.8	17.1	21.5
2	22.6	23.4	25	25.8	25	25.8	22.4	23.2

Kinetic Series Manual Chain Hoists - 0.25 Metric Ton Lifting Capacities

Ingersoll Rand's Kinetic Series premium manual chain hoists are engineered to sustain the harshest of environments and deliver exceptional durability to meet your toughest demands. With grade 100 Electro-galvanized chain, cast hook latches, an all steel construction and an extensive use of bearings, these hoists are designed to last with minimal downtime.

Kinetic Series hoists are safe, compact and durable.

Features

- The hoists have an all steel construction for exceptional durability and are lightweight.
- Reinforced, double pawl brake with large diameter pawl springs for a highly dependable brake system.
- Single chain fall through 3 metric tons.
- A full bearing construction on load sprockets and pinion shaft for reduced pull effort and longer life.
- Premium grade 100, electro-galvanized chain designed for exceptional corrosion resistance for increased durability.
- Heavy-duty, cast hook latches are designed to minimize latch replacements.
- CE certified hoists meet or exceed regional requirements, including ASME B30.16, HST-2M.

Kinetic Series Specifications									
Model	lbs	Metric Tons	No. of Falls	Pull to lift Rated Load		Chain Weight		Shipping Weight	
				lb	kg	lb/ft	kg/ft	lb	kg
KM025	550	0.25	1	41.8	19	0.25	0.11	9.5	4.3
KM050	1,100	0.5	1	51.3	23.2	1.01	0.46	24.8	11.25
KM100	2,200	1	1	63.8	29	1.21	0.55	28.4	12.9
KM150	3,300	1.5	1	77.1	35	1.41	0.64	36	16.35
KM200	4,400	2	1	79.4	36	1.55	0.7	46.3	21
KM300	6,600	3	1	82.7	37.5	1.55	0.7	63.7	28.9
KM500	11,000	5	2	74.9	34	2.96	1.34	93.7	42.5
KM750	16,500	7.5	3	77.1	35	4.17	1.89	138.9	63
KM1000	22,000	10	4	79.4	36	5.31	2.41	231.2	104.9
KM2000	44,000	20	8	49.4 x 2	36 x 2	10.62	4.82	481.9	218.6

NOTE: Overload clutch is available on all capacities.

How to Order KM030V-20-18

Example:

Base Model	Lift	Hand Chain Drop
KM030	20	18

Overload Clutch = V



Kinetic Series Manual Chain Hoists - 0.75 to 9 Metric Ton Lifting Capacities

Ingersoll Rand's Kinetic Series premium manual chain hoists are engineered to sustain the harshest of environments and deliver exceptional durability to meet your toughest demands. With grade 100 Electro-galvanized chain, cast hook latches, an all steel construction and an extensive use of bearings, these hoists are designed to last with minimal downtime. Kinetic Series hoists are safe, compact and durable.

Features

- Heavy-Duty, cast hook latches are designed to minimise latch replacements.
- Corrosion resistant finish for additional durability.
- Ergonomic handle grip to reduce fatigue.
- Capacities from .75 metric ton to 9 metric ton.
- Single chain fall through 3 metric tons; less chain equals less weight.
- A full bearing construction on load sprocket and pinion shaft for reduced chain pull effort and longer life.
- A fused brake disc for exceptional long brake life.
- Premium grade 100, electro-galvanized chain designed for exceptional corrosion resistance for increased durability.
- Compact design for the tightest of spaces.
- CE certified hoists meet or exceed regional requirements, including ASME B30.21, HST-3M.

Kinetic Series Specifications									
Model	lbs	Metric Tons	No. of Falls	Pull to lift Rated Load		Chain Weight		Shipping Weight	
				lb	kg	lb/ft	kg/ft	lb	kg
KL075	1,650	0.75	1	48.3	21.9	0.47	0.21	13.4	6.1
KL100	2,200	1	1	66.1	30	0.47	0.21	13.9	6.3
KL150	3,300	1.5	1	68.1	30.9	0.74	0.34	18.7	8.5
KL300	6,600	3	1	83.6	37.9	1.48	0.67	31.3	14.2
KL600	13,200	6	2	85.9	39	2.95	1.34	58.6	26.6
KL900	19,800	9	3	88.1	40	4.43	2.01	102.5	46.5

NOTE: Overload clutch is optional on all capacities. Shipyard hooks are available with 1.5 ton and 3.0 ton capacities only.

Kinetic Series Dimensions																		
Model	A		B		C		D		E		F		G		H		I	
	mm	in	mm	in	mm	in	mm	in	mm	in	mm	in	mm	in	mm	in	mm	in
KL075	158	6.2	119	4.7	37	1.5	280	11.0	245	9.6	108	4.3	28	1.1	35.5	1.4	14.5	0.6
KL100	158	6.2	119	4.7	45	1.8	300	11.8	245	9.6	108	4.3	33	1.3	42.5	1.7	16	0.6
KL150	176	6.9	126	5.0	47	1.9	335	13.2	265	10.4	112	4.4	33.5	1.3	42.5	1.7	18.5	0.7
KL300	210	8.3	159	6.3	62.5	2.5	395	15.6	415	16.3	128	5.0	43.5	1.7	50	2.0	27	1.1
KL600	210	8.3	218	8.6	78	3.1	540	21.3	415	16.3	128	5.0	51	2.0	60	2.4	32	1.3
KL900	210	8.3	298	11.7	-	-	680	26.8	415	16.3	128	5.0	64	2.5	85	3.3	40	1.6

How to Order KM030V-20-18

Example:

Base Model	Lift	Hand Chain Drop
KM030	20	18

Overload Clutch = V

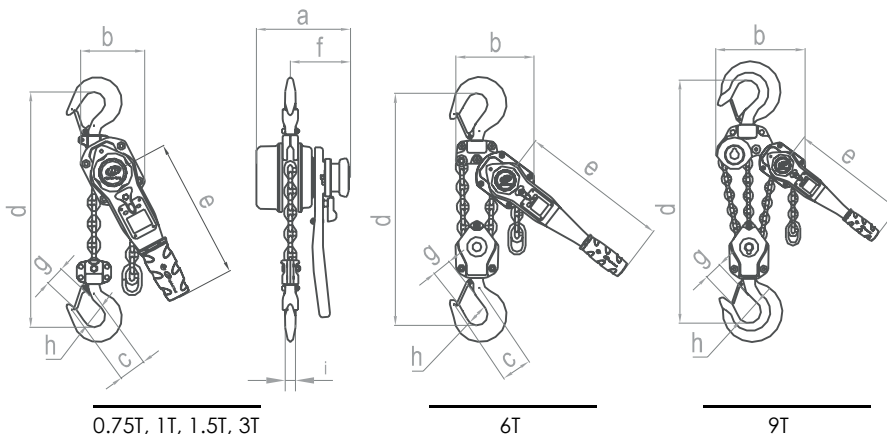

SideKick Mini Lever Hoists - 0.25 to 0.75 Metric Ton Lifting Capacities

Ingersoll Rand's Kinetic Series premium manual chain hoists are engineered to sustain the harshest of environments and deliver exceptional durability to meet your toughest demands. With grade 100 Electro-galvanized chain, cast hook latches, an all steel construction and an extensive use of bearings, these hoists are designed to last with minimal downtime. Kinetic Series hoists are safe, compact and durable.

Features

- Ultra-compact to fit into the smallest of spaces.
- Grade 80 zinc-plated or grade 100 electro-plated load
- Chain with exceptional corrosion resistance for increased durability.
- A heavy-duty carry bag with all KX lever hoists as standard.
- Double pawl, disc brake system for a highly dependable brake system.
- Heat treated steel side plates for increased durability.



Carrying bag is included with all KX lever hoists.

SideKick Series Specifications							
Model	lbs	Metric Tons	Chain Length		Pull to lift Rated Load		Chain Weight
			ft	lb	kg	lb/ft	
Lever chain Hoists							
KX025-5	550	0.25	5	3.2 x 9	3.7	1.7	
KX050-5	1.100	0.5	5	4.3 x 12	5.6	2.7	
KX075-5	1.650	0.75	5	5 x 15	7.9	3.6	
KX025-10	550	0.25	10	3.2 x 9	4.4	2	
KX050-10	1.100	0.5	10	4.3 x 9	7.3	3.3	
KX075-10	1.650	0.75	10	5 x 15	9.7	4.4	
Manual Chain Hoists							
KM025-10-8	550	0.25	10	4 x 12	9.5	4.3	

SideKick Series Dimensions																		
Model	A		B		C		D		E		F		G		S		T	
	mm	in	mm	in	mm	in	mm	in	mm	in	mm	in	mm	in	mm	in	mm	in
KX025	87	3.4	68.0	2.7	200	7.9	145	5.7	55.5	2.2	35.5	1.4	21	0.8	32	1.3	11	0.4
KX050	100.5	4.0	81.0	3.2	250	9.8	160	6.3	62.5	2.5	42	1.7	24.5	1.0	34.5	1.4	12	0.5
KX075	105	4.1	92.0	3.6	260	10.2	180	7.1	64	2.5	42	1.7	28.5	1.1	35.5	1.4	14	0.6

How to Order KM030V-20-18

Example:

Base Model **Lift** **Hand Chain Drop**
KM030 20 18

Overload Clutch = V

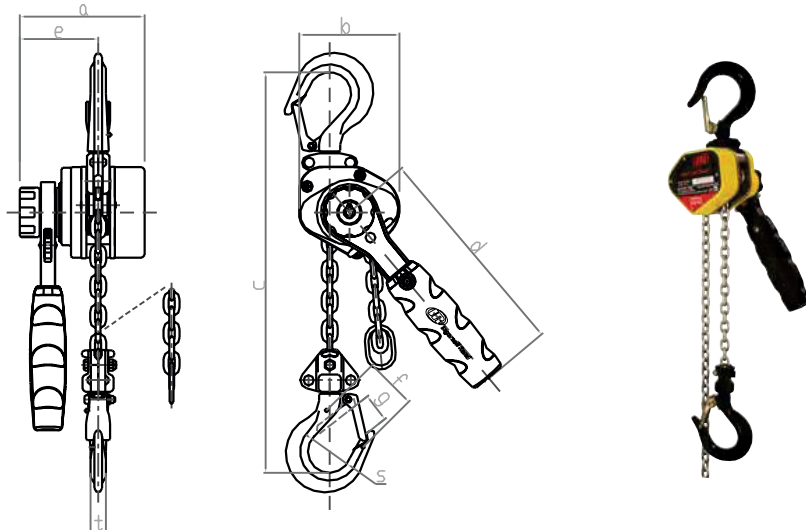



B0000817



B0000818



B0000819

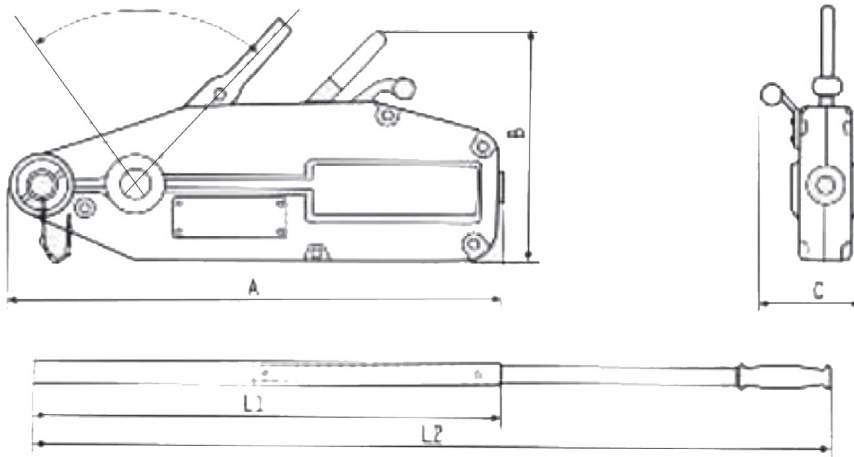

Wire Rope Pulling Hoist			
Stock Code	LR9015	LR9018	LR9021
Model	H008	H016	H032
Lifting Capacity (Kg)	800	1600	3200
Rated Pulling Capacity (Kg)	1250	2500	5000
Rope Advance per Full Stroke (mm)	60	60	40
Lever Pull at WII (Kg)	25	30	50
Rope Diameter (mm)	8.3	11	16
Standard Length of Wire Rope (m)	20-30	20-30	20-30
Net Weight without Cable (Kg)	7	14	23
Max. Overall Size (cm)	A (Overall Length of Body)	426	545
	B (Overall Height of Body)	235	280
	C (Overall Width of Body)	64	97
L1 (cm)		80	80
L2 (cm)	80	120	120

Maxpower Grade 80 Products

Master Links						
System Code	Size	Weight	WLL	Dimensions (mm)		
		kg	T	A	B	C
B0000701	6-8	0.34	1.12	110	60	14
B0000702	7-8	0.53	2	110	60	16
B0000703	10-8	1.45	5.3	160	90	22
B0000704	13-8	2.33	8	180	100	26
B0000705	16-8	3.94	10	200	110	32
B0000706	20-8	9	17	300	160	40
B0000707	22-8	12.8	21.2	340	180	45
B0000708	26-8	17.2	31.5	350	190	50
B0000709	32-8	24.2	45	400	200	56

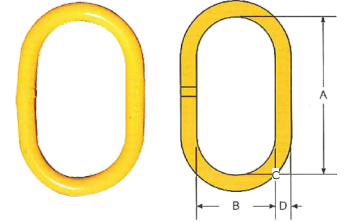

B0000701

Welded Master Link Assemblies									
System Code	Size	Weight	WLL	B	D	L	B1	D1	L1
		kg	T	(mm)	(mm)	(mm)	(mm)	(mm)	(mm)
B0000721	8	2.16	4.25	90	22	160	34	16	70
B0000722	10	3.4	6.70	100	26	180	40	18	85
B0000723	13	6.1	11.20	110	32	200	50	22	115
B0000724	16	9.9	17	140	36	260	65	26	140
B0000725	20	23.3	26.5	190	50	350	70	32	150
B0000726	22	25.8	31.5	190	50	350	75	36	170
B0000727	26	47	45	200	56	400	80	40	170

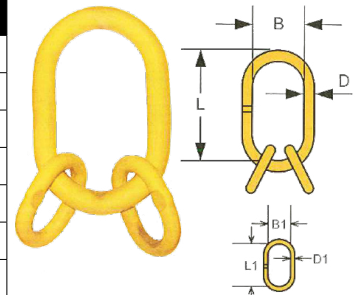

B0000721

Lifting Chain G80							
System Code	Size	Width (mm)	Outside	Approx	Working	Test Load	Breaking
	mm	Inside min.	max.	Weight	Load Limit	kN	Load min.
		a	b	kg/m	T		kN
B0000710	6x18	7.5	21	0.79	1.1	27	45.2
B0000711	7x21	9	24.5	1.07	1.5	37	61.6
B0000712	8x24	10	28	1.38	2	48	80.40
B0000713	10x30	12.5	35	2.2	3.2	76	125
B0000714	13x39	16.3	46	3.8	5	128	214
B0000715	16x48	20	56	5.63	8	192	320
B0000716	20x60	25	70	8.6	12.5	300	500
B0000717	22x66	28	77	10.2	15.3	366	610
B0000718	26x78	35	91	14.87	21.3	510	850



B0000710

Connecting links							
System Code	WLL	Size	Weight	A	B	K	D
	T		kg	(mm)	(mm)	(mm)	(mm)
B0000692	1.2	6-8	0.1	16.2	37	42	7
B0000693	2	7/8-8	0.2	20.5	48	58	8.5
B0000694	3.2	10-8	0.35	28	60	68	10.8
B0000695	5.3	13-8	0.70	30	76	90	15
B0000696	8	16-8	1.20	36.3	91	101.9	19.8
B0000697	12.5	18/20-8	1.90	44	109	121	24
B0000698	15	22-8	3.00	51	130	141.5	26
B0000699	21.2	26-8	4.70	58	152	161	30
B0000700	31.5	32-8	8.70	67.5	190	197	37

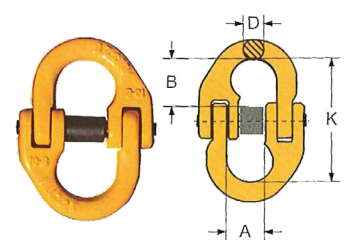

B00006925

Eye Hook Safety Latchlocks

System Code	WLL	Weight	Size	A	P	H	K	D	T
	T	kg		(mm)	(mm)	(mm)	(mm)	(mm)	(mm)
B0000756	1.2	0.46	6-8	21	7.5	20.5	110	11	15.5
B0000757	2	0.79	7/8-8	24	35	25	130	13	20
B0000578	3.2	1.52	10-8	30	43	31	172	16	27
B0000759	5.3	2.87	13-8	40	51	42	207	20	32
B0000760	8	5.69	16-8	60	82	53	250	23	45
B0000761	12.5	7.15	18/20-8	63	88	58	270	28	47

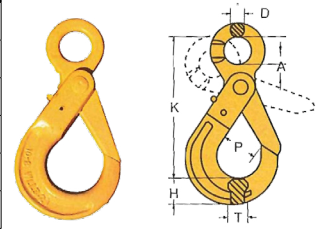

B0000756

Clevis Hook Safety Latchlocks

System Code	WLL	Weight	Size	K	H	P	T	M
	T	kg		(mm)	(mm)	(mm)	(mm)	(mm)
B0000763	1.2	0.5	6-8	99	20.5	27.5	15.5	8
B0000764	2	0.86	7/8-8	123	25	35	20	9
B0000765	3.2	1.41	10-8	146	31	43	27	11
B0000766	5.3	2.73	13-8	185	42	51	32	14
B0000767	8	5.60	16-8	222	53	82	45	18
B0000768	12.5	6.50	18/20-8	228	58	88	47	26
B0000769	15	16.00	22-8	256	64	88	48	28

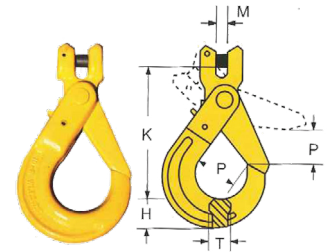

B0000763

Swivel Hook Safety Latchlocks

System Code	WLL	Weight	Size	A	B	P	H	K	D	T
	T	(kg)		(mm)	(mm)	(mm)	(mm)	(mm)	(mm)	(mm)
B0000770	1.2	0.7	6-8	32	23	27.5	20.5	149	12	15.5
B0000771	2	1.21	7/8-8	34.5	29	35	25	187	125	20
B0000772	3.2	2.00	10-8	42	37	43	31	223	155	27
B0000773	5.4	3.50	13-8	49	41	51	42	268	17	32
B0000774	8	7.10	16-8	61	54	82	53	330	22	45
B0000775	12.5	12.00	18/20-8	72	70	88	58	365	24	47

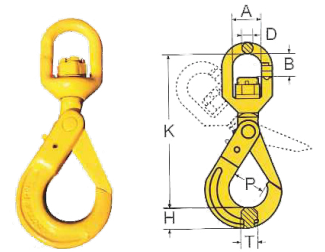

B0000770

Eye Sling Hooks with Latches

System Code	WLL	Weight	Size	A	K	H	T	P	D
	T	(kg)		(mm)	(mm)	(mm)	(mm)	(mm)	(mm)
B0000732	1.2	0.31	6-8	20	80	19	16.5	25.5	9
B0000795	3.2	1.09	10-8	38	120	32	20	34	15
B0001569	5.3	2.07	13-8	43	153	42	31	39	19
B0000732	8	3.17	16-8	50	185	48	38	49	23
B0000733	12.5	6.44	20-8	62	217	58	52	44	24

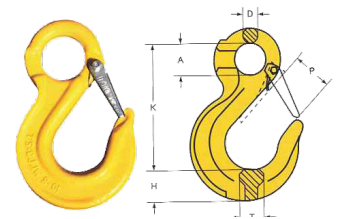

B0000732

Clevis Sling Hooks with Latches

System Code	WLL	Weight	Size	K	H	T	P1
	T	(kg)		(mm)	(mm)	(mm)	(mm)
B0000734	1.2	0.41	6-8	75	22	15.5	23.5
B0000735	3.2	1.05	10-8	104	35	25.5	34
B0000736	5.3	1.67	13-8	128	42	29.5	40
B0000737	8	3.71	16-8	150	52	37.5	45
B0000738	12.5	6.05	20-8	180	55	51	48

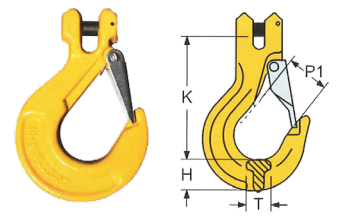

B0000734

Maxpower Grade 80 Products

Eye Grab Hooks

System Code	WLL	Weight	Size	A	K	P	G	F
	(T)	(kg)		(mm)	(mm)	(mm)	(mm)	(mm)
B0000739	1.2	0.135	6-8	13	75	8.5	8	22
B0034611	2	0.25	7/8-8	16.5	87	10	9	35
B0000741	3.2	0.70	10-8	20	120	13	14.5	47
B0000742	5.3	1.325	13-8	26	155	15	17	58
B0000743	8	2.30	16-8	29	168	17.5	22	71
B0000744	12.5	4.00	20-8	35	169	22	23	98
B0000745	15	5.65	22-8	41	172	24	26	110

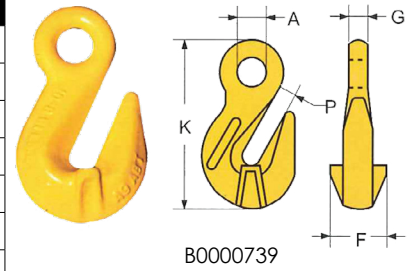

Clevis Grab Hooks

System Code	WLL	Weight	Size	A	K	P	F	H
	(T)	(kg)		(mm)	(mm)	(mm)	(mm)	(mm)
LR8095	1.2	0.12	6-8	6.7	42	8	24	16.5
B0000749	3.2	0.68	10-8	13	72	13	44	33
B0000750	5.3	1.30	13-8	17	88	17	53	40
B0000752	12.5	4.25	20-8	24	117	24	86	55

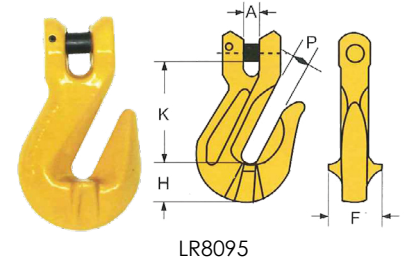

Foundry Eye Hooks

System Code	WLL	Weight	Size	A	D	P	K	H	T
	(T)	(kg)		(mm)	(mm)	(mm)	(mm)	(mm)	(mm)
B0000787	2	1.09	1/4	16	12	63.5	120	31	25
B0000788	3.2	1.95	3/8	19	16	76	146	33	32
B0000789	5.3	3.22	1/2	25	19	89	175	44.5	38
B0000790	8	5.26	5/8	31.5	20	101	205	51.5	46
B0000791	12.5	9.07	3/4	38	25	114	235	65	56
B0000792	15	11.79	7/8	44	28.5	127	264	68.5	57

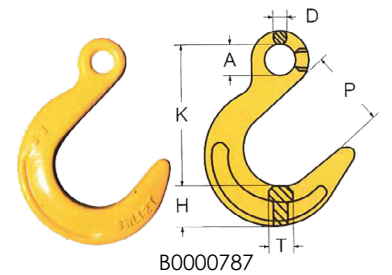

Shortening Clutches

System Code	WLL	Weight	Size	A	B	C	D	E	F	P
	(T)	(kg)		(mm)	(mm)	(mm)	(mm)	(mm)	(mm)	(mm)
B0000776	1.2	0.31	6-8	7	7	8	7.5	12	43	7
B0000777	2	0.385	7/8-8	9	8.5	10	10	18	64	9
B0000778	3.2	0.97	10-8	12.5	12	15	12	28	90	13
B0000779	5.3	1.92	13-8	16.5	16	19	15.5	34.5	115	16
B0000780	8	2.90	16-8	20.5	21	20.5	19.5	40	143	21
B0000781	12.5	5.20	20-8	22	22	24	22.5	46	152	24

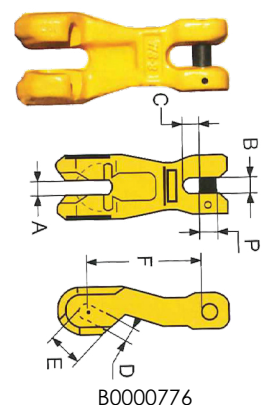

Mild Steel & Utility Chains

Short Link Chain						
Chain Size	Working Load Limit (Metric Tons)	Link Dimensions (mm)			Links per Metre	Mass per Metre in Kg (Approx)
		d-nom	L-nom	W-max		
4.0	0.2	4.0	14.3	69.9	69.9	0.34
5.6	0.4	5.6	18.8	53.2	53.2	0.67
6.3	0.5	6.3	18.9	52.9	52.9	0.88
7.0	0.6	7.0	21.0	48.2	48.2	1.08
8.0	0.8	8.0	24.0	41.7	41.7	1.41
9.0	1.0	9.0	27.0	37.0	37.0	1.79
10.0	1.2	10.0	30.0	33.3	33.3	2.21
11.2	1.6	11.2	33.6	29.8	29.8	2.77
13.0	2.2	13.0	39.0	25.6	25.6	3.73
14.0	2.5	14.0	42.0	23.8	23.8	4.32
16.0	3.3	16.0	48.0	20.8	20.8	5.65
20.0	5.0	20.0	60.0	16.7	16.7	8.82
22.0	6.2	22.0	66.0	15.2	15.2	10.68
26.0	8.7	26.0	78.0	12.8	12.8	14.90

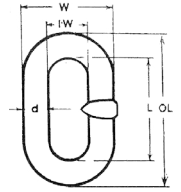

L/S Link Chains						
Chain Size	Working Load Limit (Metric Tons)	Link Dimensions (mm)			Links Per Metre	Mass Per Metre In Kg (Approx)
		D-Nom	L-Nom	W-Max		
5.6	0.3	5.6	22.4	19.6	44.6	0.62
6.3	0.4	6.3	25.2	22.1	39.7	0.79
7.1	0.5	7.1	28.4	24.9	35.2	1.00
9.0	0.8	9.0	36.0	31.5	27.8	1.60
10.0	1.0	10.0	40.0	35.0	25.0	1.98
11.2	1.2	11.2	44.8	39.2	22.3	2.49
12.5	1.5	12.5	50.0	43.8	20.0	3.10
14.0	1.9	14.0	56.0	49.0	17.9	3.88
16.0	2.5	16.0	64.0	56.0	15.6	5.07
20.0	3.8	20.0	80.0	70.0	12.5	7.92
25.0	3.0	25.0	100.0	87.5	10.0	12.40



Extra L/S Link Chains						
Chain Size	Working Load Limit (Metric Tons)	Link Dimensions (mm)			Links per Metre	Mass per Metre in Kg (Approx)
		d-nom	L-nom	W-max		
5.6	0.3	5.6	22.4	19.6	44.6	0.62
6.3	0.4	6.3	25.2	22.1	39.7	0.79
7.1	0.5	7.1	28.4	24.9	35.2	1.00
9.0	0.8	9.0	36.0	31.5	27.8	1.60
10.0	1.0	10.0	40.0	35.0	25.0	1.98
11.2	1.2	11.2	44.8	39.2	22.3	2.49
12.5	1.5	12.5	50.0	43.8	20.0	3.10
14.0	1.9	14.0	56.0	49.0	17.9	3.88
16.0	2.5	16.0	64.0	56.0	15.6	5.07
20.0	3.8	20.0	80.0	70.0	12.5	7.92
25.0	3.0	25.0	100.0	87.5	10.0	12.40

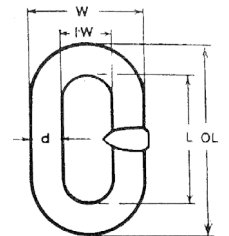

Extra L/S Link Chains - ELL Chains						
Chain Size	Working Load Limit (Metric Tons)	Link Dimensions mm			Links per Metre	Mass per Metre in Kg (Approx)
		d-nom	L-nom	W-max		
4.0	0.15	4.0	20.0	16.0	50.0	0.31
4.8	0.19	4.8	26.0	20.0	38.5	0.43
5.6	0.30	5.6	27.0	22.0	37.0	0.60



Rim Link Chains - RL Chains						
Chain Size	Working Load Limit (Metric Tons)	d-nom	L-nom	W-max	Links per Metre	Mass per Metre in Kg (Approx)
4.8	0.17	4.8	38.0	17.0	26.3	0.37
5.6	0.27	5.6	38.0	21.0	26.3	0.53
8.0	0.54	8.0	50.0	29.0	20.0	1.11



Knotted Link Chains - KL Chains						
Chain Size	Working Load Limit (Metric Tons)	d-nom	L-nom	W-max	Links per Metre	Mass per Metre in Kg (Approx)
1.6	-	1.6	23.0	7.2	43.5	0.06
2.0	-	2.0	28.0	9.0	35.7	0.08
2.8	-	2.8	46.0	15.0	21.7	0.15
3.5	-	3.5	48.0	18.0	20.8	0.27
4.0	-	4.0	54.0	20.0	18.5	0.35
5.0	-	5.0	60.0	22.5	16.7	0.56



Rin Link Chains - TL Chains						
Chain Size	Working Load Limit (Metric Tons)	d-nom	L-nom	W-max	Links per Metre	Mass per Metre in Kg (Approx)
5.6	-	5.6	20.6	20.8	48.5	0.65
6.3	-	6.3	23.0	22.1	43.4	0.84
7.1	-	7.1	27.0	24.6	37.0	1.02



LIFTING EQUIPMENT

Tensioner Selectors

Ratchet Binders

- Continuous take-up feature with infinite adjustment.
- A one piece assembly, no bolts and nuts to loosen. Ratchet spring is rust-proof.
- All load bearing or holding parts are forged.
- Eye bolts and hooks are made from Alloy Steel, quenched and tempered.
- Easy to operate-positive ratchet.



Ratchet Binder Specifications						
System Code	Chain Size	Handle Length	Barrel Length	Take-up	Minimum Breaking Strength	Mass
	mm	mm	mm	mm	kg	kg
B0000098	10/13	356	254	200	15000	5.6

Lever Binders

- Drop-forged and heat treated.
- Each binder is proof tested.



Lever Binder Specifications					
System Code	Chain Size	Handle Length	Take-up	Minimum Breaking Strength	Mass
	mm	mm	mm	kg	kg
B0000099	10	405	121	8620	3.50
B0000100	13	470	130	12700	5.10

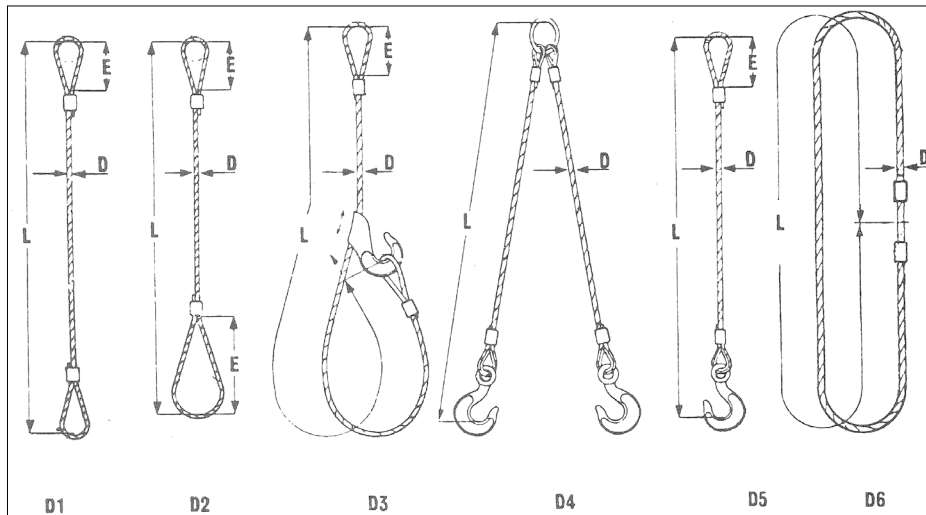

- Wire rope slings are made to any specifications required.
- Specify the diameter and give the sizes required as shown by the letters L-D-E.

Slings made up in Afgrip Aluminium Swage and Superloop Steel Swage Standard Eye Sizes are in mm.

- Eye sizes larger than standard are to be specified.
- A rubber covering for a steel wire rope sling is available.
- Slings in diameters not indicated are also available.

PLEASE NOTE: Slings are proofloaded & test certificates are supplied.

Diameter of Rope	Afgrip	Superloop
6 mm	100	100
8 mm	130	130
10 mm	150	150
13 mm	200	200
16 mm	250	250
19/20 mm	300	300
22 mm	350	350
26 mm	380	400
28 mm	450	450
32 mm	600	-

LIFTING EQUIPMENT

Wire Rope Slings

Types of Splices Available

Superloops



- Flemish eye with a robust tapered steel ferrule.
- Highly Efficient.
- Tapered to prevent snagging.
- No galvanic action between the rope and the ferrule.
- Recommended for fiery coal mines.
- Does not have low spark.

Afgrips



- Turnback eye with Aluminium ferrule.
- Economic and efficient.

Hand Splices



- Standard Liverpool or Admiralty methods.
- Other special hand splices are available.

Ferrule Mechanical Splices Complete with Thimbles



Wire Rope Clamps



- Convenient for on-site use. **(NOTE:** Correct method of fitting).
- Not recommended for sling applications.

Wire Rope Clamps



- Cane trailer rope with "Dimple" end stop.
- End stop can withstand high tension.
- Flexible rope
- High strength

Tapered Ends



- Useful for reeving steel wire rope through systems, tiffors and for fitting wedge sockets.
- Eliminates seizing of steel rope.

White Metal, Zinc and Resin Sockets

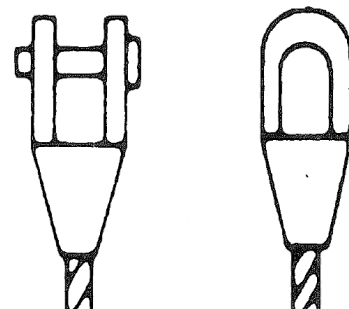

Pictures may vary from the actual product.

Steel Wire Rope Slings Safe Mass Loads of Wire Rope Sling Assemblies

Rope Construction	Rope Diameter mm	Est. Break- ing force M.Tons	Min. Permitted Factor of Safety												* Max Permitted Angle 90°	
			1 Leg - 1 Part			1 Leg - 2 Part			2 Leg - 1 Part Each				2 Legs - 2 Parts Each			Endless
			Vertical Lift	Choker Hitch	Halving Sling	Cradle Sling	30°	60°	90°	120°	Reeving Sling	Double Wrap	Cradle Sling	Endless with bight		
6x19 (12/6/1)/F 1800 MPa RH Ordinary Lay	10	5.85	0.98	0.73	1.46	1.38	1.88	1.69	1.38	0.98	1.03	2.76	1.10	10		
	11	7.04	1.17	0.88	1.76	1.66	2.26	2.03	1.66	1.17	1.24	3.32	1.32	11		
	13	7.93	1.32	0.99	1.98	1.87	2.55	2.29	1.87	1.32	1.40	3.73	1.49	13		
	14	9.37	1.56	1.17	2.34	2.21	3.01	2.70	2.21	1.56	1.65	4.41	1.75	14		
6x24 (12/12/P)P or (15/9/F)F	16	12.61	2.10	1.57	3.15	2.97	4.06	3.64	2.97	2.10	2.23	5.94	2.36	16		
	18	15.36	2.56	1.92	3.84	3.62	4.94	4.43	3.62	2.56	2.71	7.23	2.88	18		
1800 MPa	20	19.44	3.24	2.43	4.85	4.58	6.25	5.61	4.58	3.24	3.43	9.15	3.64	20		
	22	23.99	3.99	3.00	5.99	5.65	7.72	6.92	5.65	3.99	4.24	11.30	4.49	22		
RH Ordinary Lay	24	27.30	4.54	3.41	6.82	6.43	8.78	7.87	6.43	4.54	4.82	12.85	5.11	24		
	26	32.65	5.44	4.08	8.15	7.69	10.50	9.42	7.69	5.44	5.77	15.38	6.12	26		
	13	10.48	1.75	1.31	2.63	2.47	3.38	3.03	2.47	1.75	1.86	4.95	1.97	13		
	14	12.13	2.02	1.51	3.02	2.85	3.90	3.49	2.85	2.02	2.14	5.70	2.27	14		
	16	14.98	2.66	1.99	3.98	3.76	5.13	4.60	3.76	2.66	2.82	7.51	2.99	16		
	18	20.38	3.40	2.55	5.10	4.79	6.56	5.88	4.79	3.40	3.60	9.62	3.82	18		
6x36 (14/7+7/7/1)/F 1800 MPa	20	24.77	4.13	3.10	6.20	5.82	7.97	7.13	5.82	4.13	4.38	11.69	4.64	20		
RH Ordinary Lay	22	30.81	5.14	3.86	7.71	7.25	9.92	8.89	7.25	5.14	5.45	14.55	5.78	22		
	24	34.97	5.83	4.37	8.75	8.22	11.52	10.09	8.22	5.83	6.18	16.50	6.56	24		
	26	41.46	6.91	5.18	10.37	9.74	13.34	11.95	9.74	6.91	7.32	19.56	7.77	26		
	28	49.01	8.17	5.13	12.26	11.52	15.77	14.13	11.52	8.17	8.66	23.12	9.19	28		
	32	64.08	10.68	8.01	16.02	15.06	20.61	18.48	15.06	10.68	11.32	30.22	12.02	32		
Load Factor of Sling Assembly (effect of sling configuration)			1.00	0.75	1.50	1.41	1.93	1.73	1.41	1.00	1.06	2.83	1.50	-		

Test certificates are available on request.

Steel Wire Rope

Nominal Rope Diameter	Estimated Mass	Estimated Breaking Force Depending on Tensile	Safe Mass Load Factor of Safety 6:1	Safe Mass Load Factor of Safety 5:1
mm	kg/m	Tons Force	Tons	Tons
12	0.560	8.92	1.49	1.78
14	0.750	12.11	2.02	3.42
16	0.997	15.85	2.64	3.17
18	1.228	20.01	3.34	4.00
20	1.550	24.73	4.12	4.95
22	1.903	28.93	4.82	5.79
24	2.184	35.60	5.93	7.12

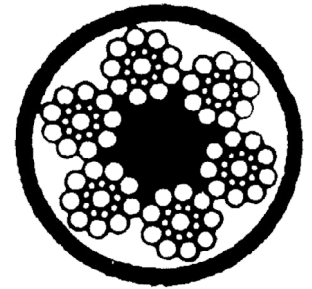

6 x 19 (9/9/1)/F

Nominal Rope Diameter	Estimated Mass	Estimated Breaking Force Depending on Tensile	Safe Mass Load Factor of Safety 6:1	Safe Mass Load Factor of Safety 5:1
mm	kg/m	Tons Force	Tons	Tons
6	0.117	1.93	0.32	0.39
10	0.331	5.36	0.89	1.07
12	0.449	7.59	1.27	1.52
13	0.569	9.52	1.59	1.90
14	0.677	10.21	1.70	2.04
16	0.807	13.41	2.23	2.68
18	1.041	15.51	2.59	3.10
20	1.301	19.53	3.26	3.91
22	1.568	24.96	4.16	4.99
24	1.840	27.58	4.60	5.52

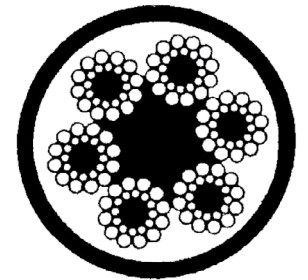

6 x 24 (12/12/P)/P

Nominal Rope Diameter	Estimated Mass	Estimated Breaking Force Depending on Tensile	Safe Mass Load Factor of Safety 6:1	Safe Mass Load Factor of Safety 5:1
mm	kg/m	Tons Force	Tons	Tons
10	0.437	6.64	1.11	1.33
11	0.527	8.24	1.37	1.65
13	0.743	11.27	1.88	2.25
14	0.858	13.40	2.23	2.68
16	1.130	16.90	2.82	3.38
20	1.766	27.74	4.62	5.55
22	2.112	33.26	5.54	6.65
24	2.480	39.03	6.51	7.81
26	2.925	45.99	7.67	9.20

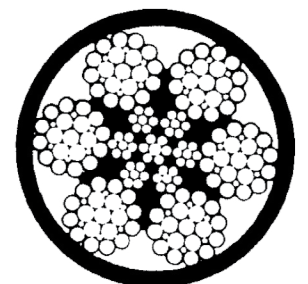

6 x 25 (12/6/6/1)/IWRC

Test Certificates are available on request.

Steel Wire Ropes

Nominal Rope Diameter	Estimated Mass	Estimated Breaking Force Depending on Tensile	Safe Mass Load Factor of Safety 6:1	Safe Mass Load Factor of Safety 5:1
mm	kg/m	Tons Force	Tons	Tons
10	0.395	6.26	1.04	1.25
13	0.671	10.48	1.75	2.10
16	1.006	15.98	2.66	3.20
19	1.275	20.38	3.40	4.08
20	1.575	24.77	4.13	4.95
22	1.908	30.81	5.14	6.16
26	2.627	41.46	6.91	8.29
28	3.064	49.01	8.17	9.80
32	4.028	64.08	10.68	12.82

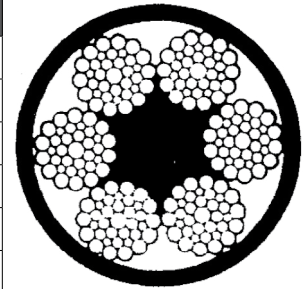

6 x 36 (14/7-7/7/1)/F
GALVANISED

Nominal Rope Diameter	Estimated Mass	Estimated Breaking Force Depending on Tensile	Safe Mass Load Factor of Safety 6:1	Safe Mass Load Factor of Safety 5:1
mm	kg/m	Tons Force	Tons	Tons
13	0.747	11.59	1.93	2.32
16	1.125	17.61	2.94	3.52
20	1.749	27.47	4.59	5.50
22	2.167	33.39	5.56	6.68
30	3.916	62.66	10.44	12.53
32	4.502	71.61	11.94	14.32
36	5.584	89.61	14.94	17.92
38	6.210	98.37	16.40	19.67
42	7.717	121.73	20.29	24.35
44	8.293	134.69	22.45	26.94
48	10.049	159.80	26.63	31.96

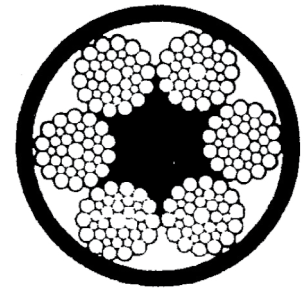

6 x 36 (14/7-7/7/1)/IWRC

18 Strand Non-Spins

Nominal Rope Diameter	Estimated Mass	Estimated Breaking Force Depending on Tensile	Safe Mass Load Factor of Safety 6:1	Safe Mass Load Factor of Safety 5:1
mm	kg/m	Tons Force	Tons	Tons
6	0.142	2.40	0.40	0.48
8	0.252	4.04	0.67	0.81
10	0.399	6.34	1.06	1.29
11	0.486	7.58	1.26	1.52
13	0.665	10.60	1.77	2.12
14	0.805	12.67	2.11	2.53
15	0.902	14.55	2.43	2.91
16	1.005	15.92	2.65	3.18
20	1.634	24.76	4.29	5.15
22	1.860	31.01	5.17	6.20
23	2.184	34.50	5.75	6.90
24	2.316	36.60	6.10	7.32

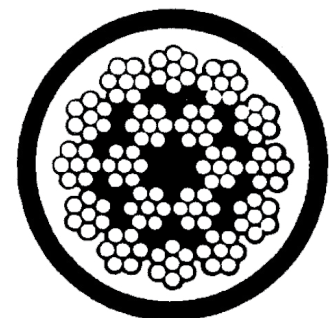

12 x 7 (6/1)/6 x 7 (6/1)/F
18 Strand Non-Spin

Test Certificates are available on request.

Stainless Steel Wire Ropes

Nominal Rope Diameter	Estimated Mass	Estimated Breaking Force Depending on Tensile	Safe Mass Load Factor of Safety 6:1	Safe Mass Load Factor of Safety 5:1
mm	kg/m	Tons Force	Tons	Tons
2.5	0.032	468	78	94
3	0.046	820	137	164
4	0.081	1191	199	238
5	0.128	2180	363	436
6	0.185	2822	470	564

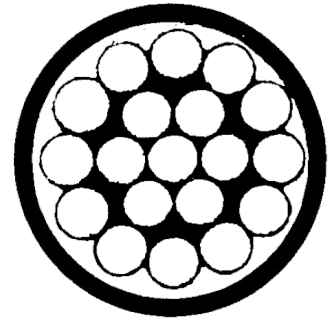

1 x 19

Nominal Rope Diameter	Estimated Mass	Estimated Breaking Force Depending on Tensile	Safe Mass Load Factor of Safety 6:1	Safe Mass Load Factor of Safety 5:1
mm	kg/m	Tons Force	Tons	Tons
1.5	0.009	162	27	32
2	0.016	284	47	57
2.5	0.026	423	71	85
3	0.037	626	104	125
5	0.105	1708	285	342
6	0.151	2373	396	475
10	0.390	6620	1103	1324

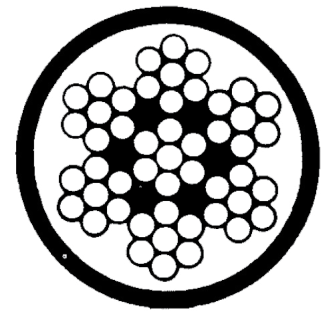

7 x 7

Nominal Rope Diameter	Estimated Mass	Estimated Breaking Force Depending on Tensile	Safe Mass Load Factor of Safety 6:1	Safe Mass Load Factor of Safety 5:1
mm	kg/m	*Tons Force	*Tons	*Tons
2	0.019	276	46	55
2.5	0.026	412	69	82
3	0.037	610	102	122
4	0.067	1067	178	213
5	0.105	1643	274	329
6	0.152	2311	384	462
8	0.269	4024	671	805
10	0.390	6048	1008	1210

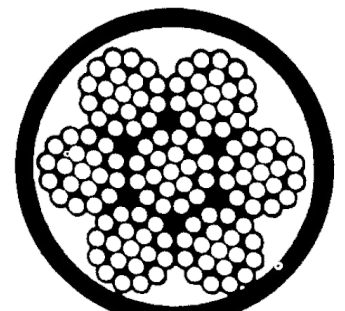

7 x 19

Test Certificates are available on request.

Thimbles

General to EN13411-1 formally BS 464

- **Material:** Mild Steel
- **Finish:** Hot-Dipped Galvanised
- **Certification:** A work certificate is available on request

System Code	Diameter Rope	Width Groove	Length	Length Inside	Width Inside	Thickness Back	Weight
	inches	mm	mm	mm	mm	mm	100 pcs
B0000070	1/4	6	48	30	20	3.5	5.4
B0000071	5/16	8	54	33	22	4	5.7
B0000072	3/8	10	64	38	25	4.8	7.6
B0000073	7/16	13	73	41	29	4.8	14.2
B0000074	5/8	17	98	59	41	7.9	34
B0000075	3/4	20	124	73	51	9.5	62.4
B0000076	7/8	23	133	83	57	9.5	75.6
B0000077	1	27	162	108	70	10.3	125
B0000078	1 1/8	29	178	111	76	12.7	151
B0000079	1 1/4	33	197	133	95	12.7	204



Standard Commercial









- **Material:** Mild Steel
- **Finish:** Electro-Galvanised

System Code	Diameter Rope	Width Groove	Length	Length Inside	Width Inside	Thickness Back	Weight
	mm	mm	mm	mm	mm	mm	100 pcs
B0000080	4	4	25	19	16	11	0.4
B0000081	5	5	31	22	22	16	0.8
B0000082	6	6	37	29	26	19	1.4
B0000083	8	8	51	38	34	24	2.8
B0000084	10	10	64	44	42	32	4.8
B0000085	12	12	76	57	51	38	8

Endless Round Slings		
Capacity	Lengths	Stock Codes
1000 kg	1 m to 10 m	LR4100 to LR4109
2000 kg	1 m to 10 m	LR4111 to LR4121
3000 kg	1 m to 6 m	LR4122 to LR4128
4000 kg	1 m to 6 m	LR4131 to LR4136
5000 kg	1 m to 10 m	LR4141 to LR4150
6000 kg	1 m to 6 m	LR4151 to LR4156

Endless Round Slings		WLL (kg) with One Round Sling							WLL (kg) with Two Round Slings			
		Straight Pull	Choke Hitch	Basket Angle					Straight Angle		Choke Hitch Angle	
				Bis 7°	7°-45°	45°-60°	7°-45°	45°-60°	7°-45°	45°-60°	7°-45°	45°-60°
Factor	Colour											
		1.0	0.8	2.0	1.4	1.0	0.7	0.5	1.4	1.0	1.12	0.8
1000 kg	Violet	1000	800	2000	1400	1000	700	500	1400	1000	1120	800
2000 kg	Green	2000	1600	4000	2800	2000	1400	1000	2800	2000	2240	1600
3000 kg	Yellow	3000	2400	6000	4200	3000	2100	1500	4200	3000	3360	2400
4000 kg	Grey	4000	3200	8000	5600	4000	2800	2000	5600	4000	4480	3200
5000 kg	Red	5000	4000	10000	7000	5000	3500	2500	7000	5000	5600	4000
6000 kg	Brown	6000	4800	12000	8400	6000	4200	3000	8400	6000	6720	4800
8000 kg	Blue	8000	6400	16000	11200	8000	5600	4000	11200	8000	8960	6400
10000 kg	Orange	10000	8000	20000	14000	10000	7000	5000	14000	10000	11200	8000

Rated Capacities for Different Slings Methods

Webbing Slings		WLL (kg) with One Webbing Sling							WLL (kg) with Two Webbing Slings			
		Straight Pull	Choke Hitch	Basket Angle					Straight Angle		Choke Hitch Angle	
				Bis 7°	7°-45°	45°-60°	7°-45°	45°-60°	7°-45°	45°-60°	7°-45°	45°-60°
Factor	Colour											
		1.0	0.8	2.0	1.4	1.0	0.7	0.5	1.4	1.0	1.12	0.8
1000 kg	Violet	1000	800	2000	1400	1000	700	500	1400	1000	1120	800
2000 kg	Green	2000	1600	4000	2800	2000	1400	1000	2800	2000	2240	1600
3000 kg	Yellow	3000	2400	6000	4200	3000	2100	1500	4200	3000	3360	2400
4000 kg	Grey	4000	3200	8000	5600	4000	2800	2000	5600	4000	4480	3200
5000 kg	Red	5000	4000	10000	7000	5000	3500	2500	7000	5000	5600	4000
6000 kg	Brown	6000	4800	12000	8400	6000	4200	3000	8400	6000	6720	4800
8000 kg	Blue	8000	6400	16000	11200	8000	5600	4000	11200	8000	8960	6400
10000 kg	Orange	10000	8000	20000	14000	10000	7000	5000	14000	10000	11200	8000

Rated Capacities for Different Slings Methods

Webbing Slings			
Capacity	Width	Lengths	Stock Codes
1000 kg	50 mm	1 m to 6 m	LR4360 to LR4365
2000 kg	60 mm	1 m to 6 m	LR4366 to LR4371
3000 kg	90 mm	1 m to 6 m	LR4372 to LR4377
4000 kg	120 mm	1 m to 6 m	LR4378 to LR4383
5000 kg	150 mm	1 m to 6 m	LR4384 to LR4389
6000 kg	180 mm	1 m to 6 m	LR4390 to LR4395
8000 kg	240 mm	1 m to 6 m	LR4396 to LR4403

Shackles

Federal Specifications

Bow Shackles (RR-C-271B)								
System Codes	SWL	A	B	C	Bow Only D	"D" Only E	Bow Only E	F
B0000561	0.5	6	8	12	19	23	27	20
B0000562	1	10	11	17	26	33	37	26
B0000563	1.5	11	13	18	29	37	44	29
B0000564	2	13	16	20	33	46	48	33
B0000565	3.25	16	20	27	43	52	61	43
B0000566	4.75	20	22	30	51	61	71	51
B0000567	6.5	22	25	36	58	76	84	58
B0000568	8.5	25	28	44	67	83	95	68
B0000569	9.5	28	32	47	73	91	107	74
B0000570	12	32	35	52	81	101	119	83
B0000571	13.5	35	38	58	91	118	134	92
B0000572	17	38	42	61	98	125	144	98
B0000573	25	44	51	74	126	150	180	127
B0000574	35	51	56	85	143	170	197	146
B0000575	55	64	70	105	184	203	267	184

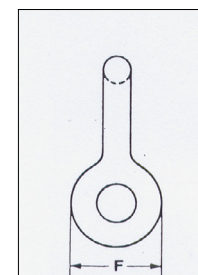
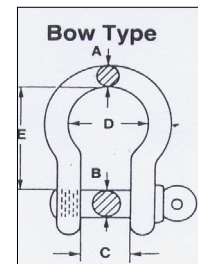

Subject to Commercial Tolerances

Federal Specifications

"D" Shackles (RR-C-271B)										
System code	SWL	A	B	C	D	E	F	G	H	kg
		mm	mm	mm	mm	mm	mm	mm	mm	
B0000577	1	10	11	23	10	17	32	66	56	0.14
B0000578	1.5	11	13	26	11	19	37	74	68	0.19
B0000579	2	13.5	16	34	13.5	22	43	85	76	0.32
B0000580	3.25	16	19	40	16	27	51	105	93	0.54
B0000581	4.75	19	22	47	19	31	59	125	107	0.87
B0000582	6.5	22	25	53	22	36	73	144	123	1.34
B0000583	8.5	25	28	60	25	43	85	161	141	2.08
B0000584	9.5	28	32	67	28	47	90	179	158	2.77
B0000585	12	32	35	74	32	51	94	199	176	3.72
B0000586	13.5	35	38	80	35	57	115	220	192	5.14
B0000587	17	38	42	89	38	60	127	239	208	5.85
B0000588	25	45	50	104	45	74	149	283	250	11.45
B0001570	35	50	57	111	50	83	171	333	281	16.86
B0000589	55	65	70	145	65	105	203	399	355	32.65

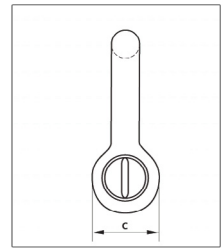
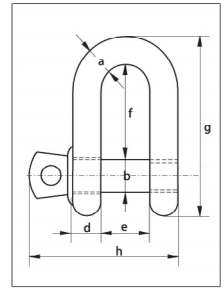

B0000577

Federal Specifications

Bolt Nut Split Pins (RR-C-271B)													
System code	SWL	A	B	C	D	E	F	G	H	I	J	K	kg
		mm	mm	mm	mm	mm	mm	mm	mm	mm	mm	mm	
B0000590	3.25	16	19	40	16	27	64	43	114	99	79	17	0.74
B0000591	4.75	19	22	47	19	31	76	51	136	115	94	20	1.18
B0000592	6.5	22	25	53	22	36	83	68	157	131	107	23	1.77
B0000593	8.5	25	28	60	25	43	95	75	176	151	124	25	2.58
B0000594	9.5	28	32	67	28	47	108	83	197	167	137	28	3.66
B0000595	12	32	35	74	32	51	115	92	218	179	154	31	4.91
B0001465	13.5	35	38	80	35	57	133	99	240	198	170	34	6.54
B0000596	17	38	42	89	38	60	146	108	262	202	183	37	8.19
B0000597	25	45	50	104	45	74	178	126	314	244	226	41	14.22
B0001571	35	50	57	111	50	83	197	138	358	270	250	45	19.85
B0000598	55	65	70	145	65	105	260	180	463	330	329	51	39.59

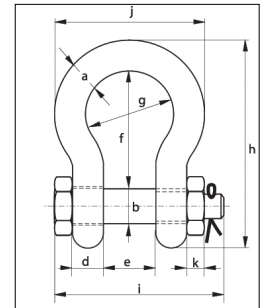

B0000590

BS3032 Table 2 (Withdrawn 1994)

- Material : Bow and Pin Alloy Steel, EN14A
- Safety Factor : MBL Equals 4 x WLL

Large DEE Shackle with Screw Collar Pins							
System Code	Diameter Rope	Width Groove	Length	Length Inside	Width Inside	Thickness Back	Weight
	Tons	mm	mm	mm	mm	mm	100 pcs
B0000669	0.25	6	10	19	13	25	0.11
	0.5	10	13	25	19	38	0.17
	0.75	13	16	32	28	54	0.35
B0000671	1.5	16	19	38	32	64	0.66
	2	19	22	44	38	73	1.02
	3	22	25	51	44	83	1.57
B0000672	3.75	25	28	57	51	95	2.3
B0000673	5	28	32	64	54	105	3.2
B0000674	6	32	35	70	60	114	4.3
B0000675	7	35	38	76	67	127	5.4
B0000676	9.5	38	45	83	70	137	6.8



B0000669

NOTE: Not for Lifting Purposes

Drop-Forged Eye Bolts (DIN580)

System Code	Thread Diameter	Safe Working Load	Inside Eye Diameter	Eye Material Diameter	Shank Length	Thread Length	Approx. Weight
B0000627	8	140	19	8	12	9	0.06
B0000628	10	230	24	10	16	13	0.11
B0000629	12	340	29	11	20	17	0.18
B0000630	16	700	34	14	27	22	0.32
B0000631	20	1200	39	16	30	25	0.45
B0000632	24	1800	49	20	36	30	0.76
B0000633	30	3600	59	25	46	38	1.88
B0000634	36	5100	70	27	60	51	2.92

Drop-Forged Eyunuts (DIN582)

System Code	Thread Diameter	Safe Working Load	Inside Eye Diameter	Eye Material Diameter	Base Diameter	Thread Length	Approx. Weight
B0000639	6	70	19	8	20	10	0.05
B0000640	8	140	19	8	20	10	0.05
B0000641	10	230	24	10	25	12	0.09
B0000642	12	340	29	11	29	13	0.16
B0000643	16	700	34	14	34	16	0.24
B0000644	20	1200	39	16	40	19	0.36
B0000645	24	1800	49	20	51	23	0.67
B0000646	30	3600	59	25	65	29	1.32



B0000639

Federal specifications

Heavy-Duty Drop-Forged Steel Galvanised Wire Rope Clamps (450, Type 1, Class 1)

System Code	A	B	C	D	E	F	G	H	I
B0000613	6	6	36	30	20	8	8	28	18
B0000614	8	8	43	34	22	9	9	38	23
B0000615	10	9	50	41	25	11	11	40	23
B0000616	13	11	57	48	31	12	12	51	27
B0000617	16	12	65	53	34	14	13	63	35
B0000618	20	13	72	57	40	16	15	68	40
B0000619	22	14	80	63	44	18	17	83	44
B0000620	26	15	88	68	49	18	19	95	51
B0000621	28	17	91	74	52	20	20	98	53
B0000622	32	20	105	79	60	22	22	112	54
B0000623	38	24	113	85	68	22	22	125	60

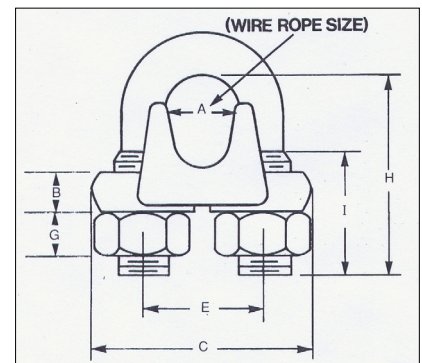

B0000613

Light-Duty Galvanised Commercial Wire Rope Clamps

System Code	A	B	C	D	E	F	G	H	I
B0000603	6	6	36	30	20	8	8	28	18
B0000604	8	8	43	34	22	9	9	38	23
B0000605	10	9	50	41	25	11	11	40	23
B0000606	13	11	57	48	31	12	12	51	27
B0000607	16	12	65	53	34	14	13	63	35
B0000608	20	13	72	57	40	16	15	68	40
B0000609	22	14	80	63	44	18	17	83	44

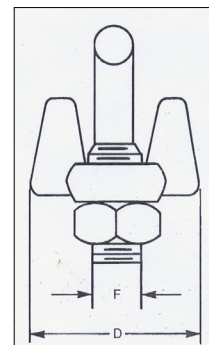

B0000603

Also Available in Stainless Steel.

Hook & Eye Turn Buckle (DIN1480)														
System Code	Dimensions	A	B	H	I	J	K	L	M	N	O	H/E Min.	H/E Max.	Safe Working Load (kg)
B0000655	M6X110	80	15	5.5	8.5	10	55	55	27	8	8	155	235	76.67
B0000656	M8X110	75	18	6	10	8	60	55	30	10	11	158	237	136.67
B0000657	M10X125	85	20	8	12.5	13	70	63	32	13	10	182	255	216.67
B0000658	M12X125	80	23	10.5	17.5	14	65	65	45	15	16	201	285	310.00
B0000659	M16X170	110	30	14	19	22	88	90	48	18.5	20	259	377	590.00
B0000660	M20X200	130	35	14	24	22	105	103	61	24	22	307	445	900.00
B0000661	M24X255	170	43	18	27	25	135	135	70	31	27	377	561	1306.67

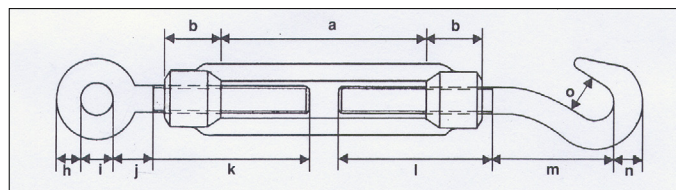

Eye & Eye Turn Buckle (DIN1480)										
System Code	Dimensions	A	B	H	I	J	K	E/E Min.	E/E Max.	Safe Working Load (kg)
B0000662	M6X110	80	15	5.5	8.5	10	55	147	227	230
B0000663	M8X110	75	18	6	10	8	60	147	221	410
B0000664	M10X125	85	20	8	12.5	13	70	176	276	650
B0000665	M12X125	80	23	10.5	17.5	14	65	189	273	930
B0000666	M16X170	110	30	14	19	22	88	252	368	1770
B0000667	M20X200	130	35	14	24	22	105	292	432	2700
B0000668	M24X255	170	43	18	27	25	135	360	544	3920

Also Available in Stainless Steel.

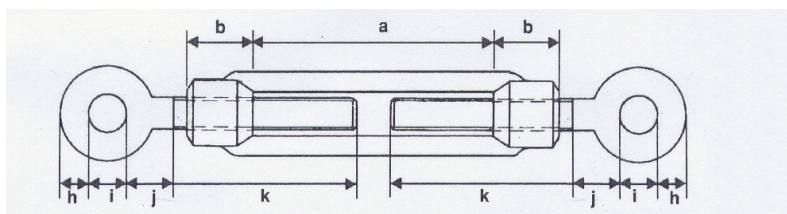



Rope Blocks for Fibre Ropes - London Pattern Type

Fitted with drop-forged steel swivel hook & safety catches

Industrial Snatch Blocks			
System Code	WLL (Tons)	Rope Seat Ø	Rope Size
B0000326	0.5	80	>10
B0000327	1	105	>12
B0000328	2	125	>16
B0000329	3	165	>20
B0000330	5	215	>25



Single Sheaves			
System Code	Rope Diameter	Sheave Diameter	SML
	mm	mm	kg
B0000308	10	65	65
B0000309	13	90	120
B0000310	16	100	200
B0000311	20	120	300
B0000312	22	125	400
B0000313	24	150	550



Double Sheaves			
System Code	Rope Diameter	Sheave Diameter	SML
	mm	mm	kg
B0000315	13	90	350
B0000316	16	100	600
B0000317	20	120	850
B0000318	22	125	1200
B0000319	24	150	1500



Treble Sheaves			
System Code	Rope Dia. meter	Sheave Diameter	SML
	mm	mm	kg
B0000321	13	90	400
B0000322	16	100	700
B0000323	20	120	1000
B0000324	22	125	1300
B0000325	24	150	2000



Beam Clamps					
System Code	SWL	Aperture		Width "W"	Hole "C"
	kg	"A" mm	"B" Max. mm	mm	mm
B0000332	1000	50-180	160	75	-
B0000333	2000	75-250	200	85	-
B0000334	3000	100-320	255	95	-
B0000335	5000	100-365	300	100	-
B0000336	10000	200-500	350	165	-



B0000842



B0001572

Vertical Plate Clamps	
System Code	Safe Working Load
B0000842	1 T
B0000843	2 T
B0000844	3 T
B0000845	6 T

Horizontal Plate Clamps	
System Code	Safe Working Load
B0001572	1.5 T
B0000846	2 T
B0000847	3 T
B0000848	5 T

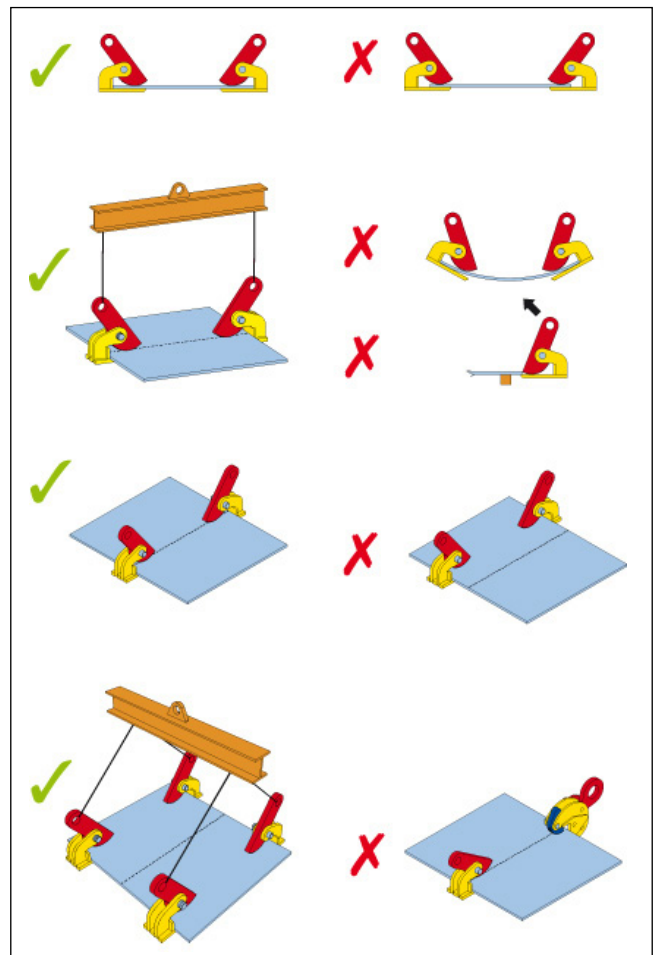
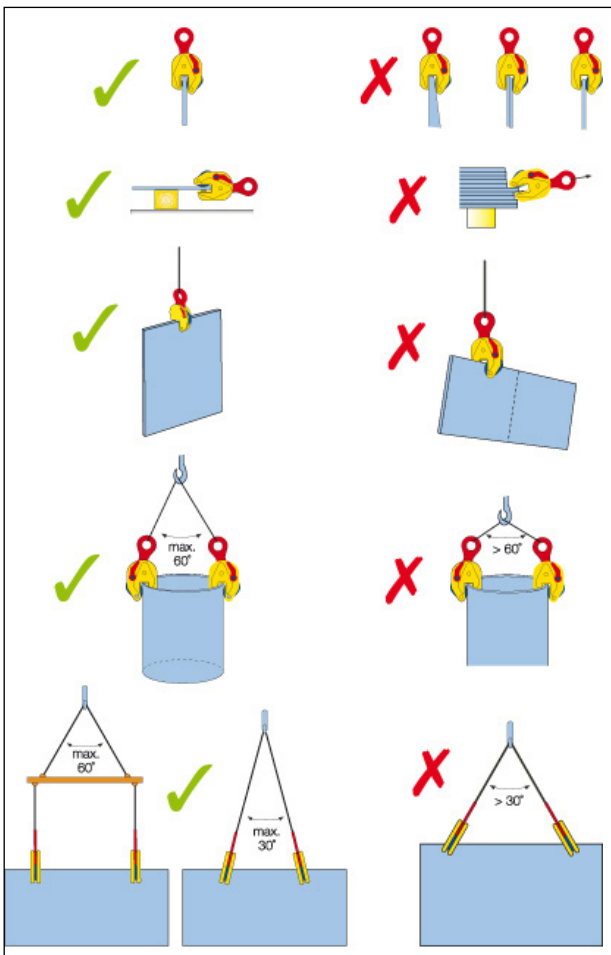

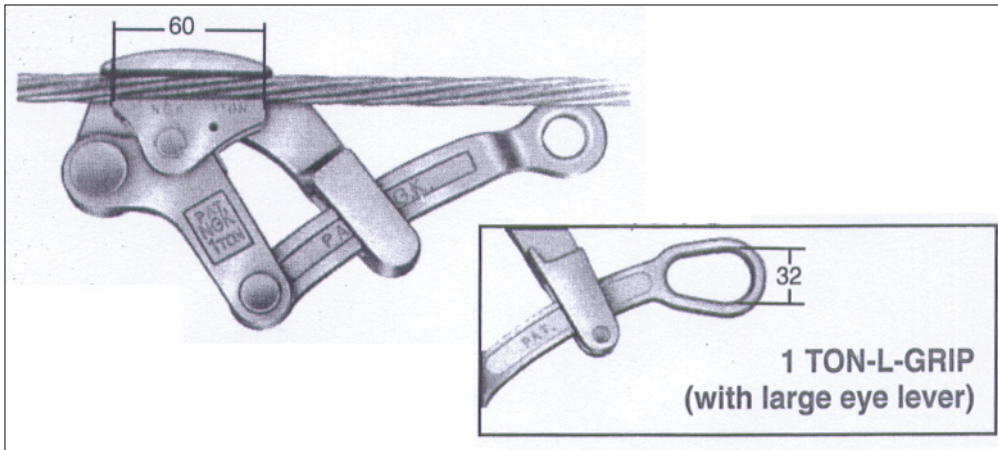

For bare copper cable, covered conductors and messenger wire

Optional
(Safety Latch)

Wire Rope Grip, 2 Ton					
System Code	Safe Load	Min Cable Dai.	Max Cable Dia.	Weight	Brand
	KN	mm	mm	kg	
	20 (2.0T)	2.4	20	1.1	Maxpower

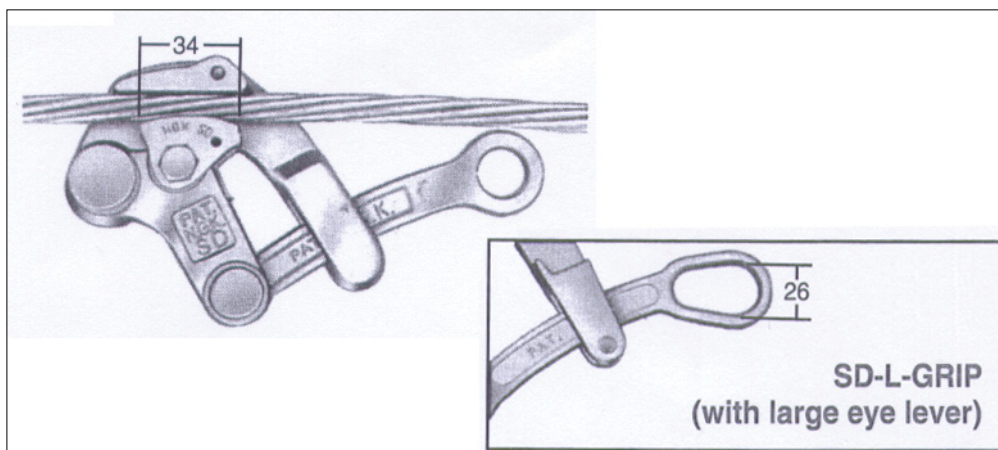

For Steel Rod, Copper Cable and Messenger Wire

Option
(Safety Latch)

Wire Rope Grip						
System Code	Safe Load	Min Cable Dai.	Max Cable Dia.	Capacity	Weight.	Brand
B0000370	10KN (1.0T)	2.6 mm	16 mm	1T	0.6 kg	MAXPOWER
B0000372	30KN (3.0T)	16 mm	32 mm	3T	2.5 kg	MAXPOWER

- Versatility – All models are rated for a variety of wire sizes and types, so fewer grip changes are required.
- No Lock Ups – Easily grips open and release instantly to quickly insert or remove wire.
- Large Handle Eye Opening – accepts standard hooks and easily attaches to tackle blocks.
- Rugged and portable
- Forged Steel Construction – Durable yet lightweight.



B0000372

Pictures may vary from the actual product.

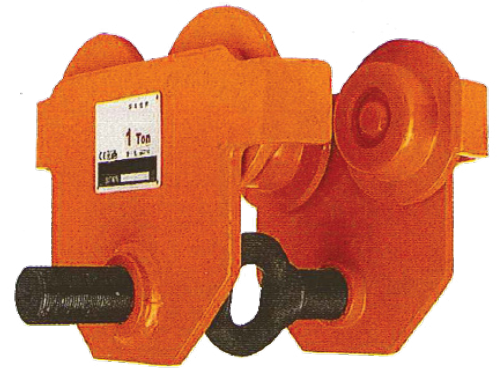
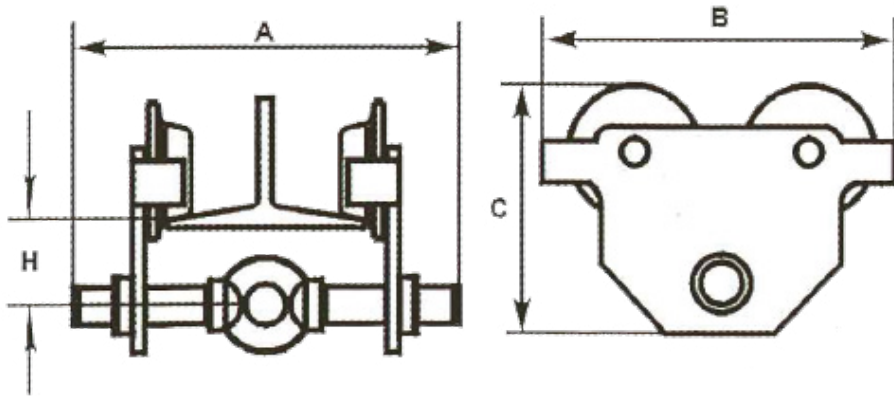

B0000825

Plain Trolley Specifications

System Code	Capacity	I-Beam Width	N.w./ Kgs	A	B	C	H
	Ton						
B0000825	0.5	50-220	5	285	198	158	64.5
B0000827	1	58-220	8.7	285	238	183	66
B0000831	2	66-220	13.9	300	277	208	75
B0000835	3	74-220	23.5	321	324	249	85
B0001565	5	90-220	40	354	373	269.5	100

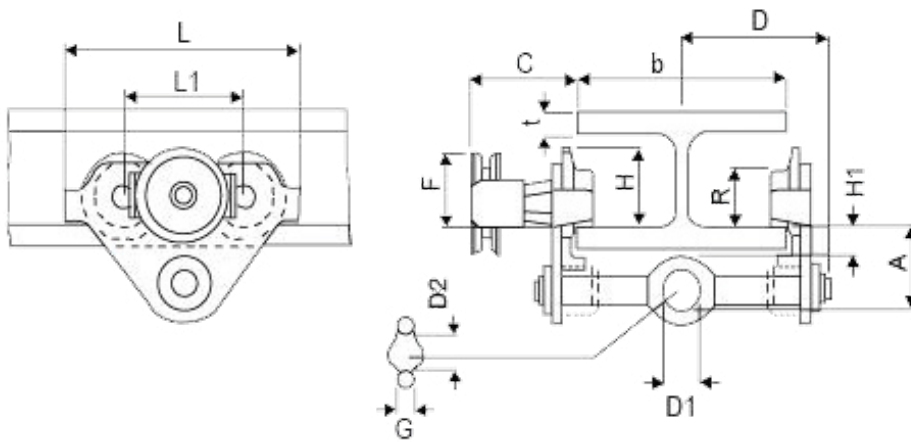

B0000359

Geared Trolley Specifications

System Code	Capacity	Beam Flange Width 'b'	Beam Flange Thickness 't'	A	C	G	D1	D2	F	H	H1	L	L1	R	D	Weight
	kg															mm
B0000359	500	50-203	40	77	110	16	25	30	91.5	76.5	30.5	260	130	60	146	9.7
B0000361	1000	50-203	25	82.5	110	17	30	35	91.5	76.5	30.5	260	130	60	150	11.2
B0000363	2000	66-203	25	98.5	110	22	40	47	90.5	98	30.5	310	150	80	155	18
B0000366	3000	74-200	25	114	100	26	48	58	107.5	132.5	30	390	180	112	160	35.4
B0000368	5000	90-203	25	132.5	110	33	60	70	149.5	148.5	30	450	209	125	167.5	51.8

Tie Downs



Cam Buckle



Flat Hook



D-Ring



J Hook



S Hook



Snap Hook wwith Eye



Falt Snap Hook

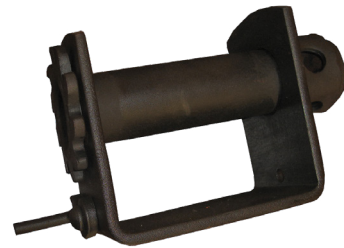

Truck Winch



Ratchet Tensioner

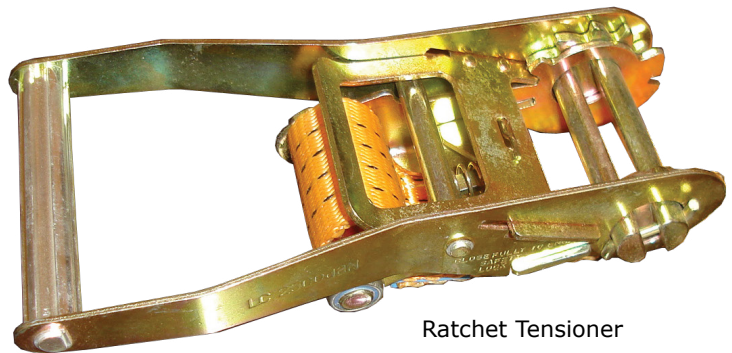

Ratchet Tensioner

System Code	Description	WLL (Ton)
B0000376	Tie Down, 9 m Strap	4†
B0000377	500 mm, Tail Comes with a Ratchet	4†